



Industrial monitor



All rights reserved

Shenzhen Syoung Technology Co., Ltd. 2020. All rights reserved.

Without the written permission of the company, any unit or individual shall not extract or reproduce part or all of the contents of this document, and shall not transmit it in any form.

Notice

Due to product version upgrades or other reasons, the content of this document will be updated from time to time. Unless otherwise agreed, this document is for use only as a guide, and all statements, information and recommendations in this document do not constitute any express or implied warranty.

Table of contents

Product Overview	3
Product Introduction.....	3
Application Scenario	3
Product Specification.....	3
Product Size & Display	5
Installation & Instructions	6
Product Care and Maintenance	21

Product description

Product introduction

This product adopts 18.5-inch display screen, capacitive touch. It adopts aluminum alloy structure, which is more beautiful and supports 7*24 hours of work; it is also compatible with Windows, Linux, and Android, making the product more widely used. Products are widely used in education, medical, industrial, smart equipment and other application scenarios.

Application scenarios

- Teaching computer, calligraphy model, integrated desk
- Registration terminal, printing terminal, inquiry terminal, self-service physical examination all-in-one machine
- CNC machine tools, manufacturing, industrial control cabinets, industrial automation production lines
- Robots, intelligent production lines, express cabinets, intelligent terminals, visual terminals

Product Specifications

Specification		Parameter
Screen	size	18.5"
	Resolution	1920×1080
	screen brightness	300cd/m ²
Capacitive touch	Surface hardness	6H
	Number of contacts	10 point
Trumpet Hardware	Built-in empty	2W+2W/8Ω;
	CPU	Taiwan well-known chip
	Interface	VGA+HDMI
	Voltage	DC 12V (direct current)
	Display language	Chinese/English/French/Spanish/Italian/German/Russian/Korean
	Key Function	OSD five keys
	Power supply	12V-3A external power adapter
Basic parameters	Power performance	AV 100-240V AC power is converted to DC 12V DC power via external power adapter, 50-60Hz
	working environment	Working temperature: -10~60°C; Working humidity: 5%~95% relative temperature, no condensation
	storage environment	Storage temperature: -20~60°C;

	Storage humidity: 5%~95% relative temperature, no condensation
Size	As shown below
Protection class	Surface IP65
Installation method	wall-mounted, desktop
Packing List	Machine*1, Power Adapter*1, Power Cord*1, Instruction Manual*1, Certificate*1

Product Size

18.5 inch industrial display

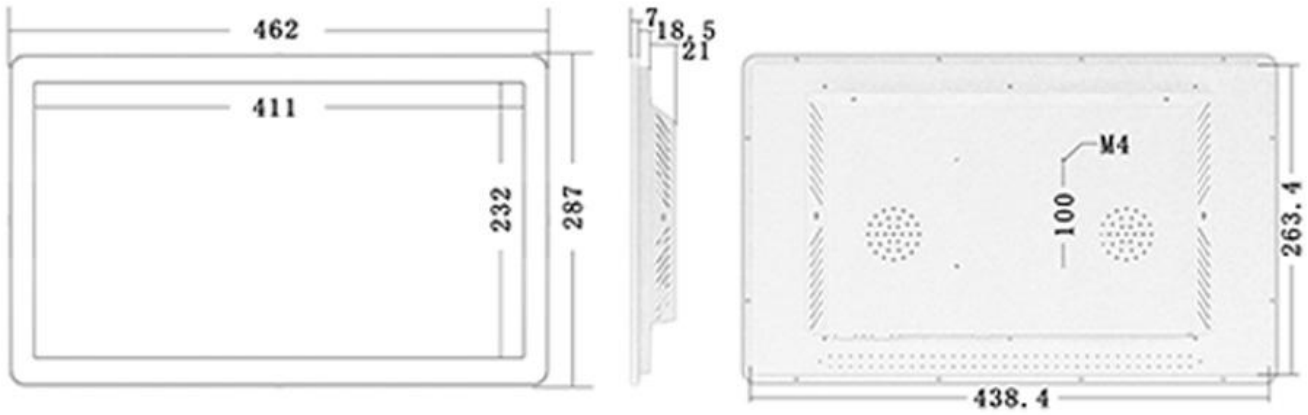

Front view

side view

back image

Warm reminder: The size unit is millimeter (mm), and the error is within $\pm 0.5\text{mm}$

Installation steps



Blind bracket installation method

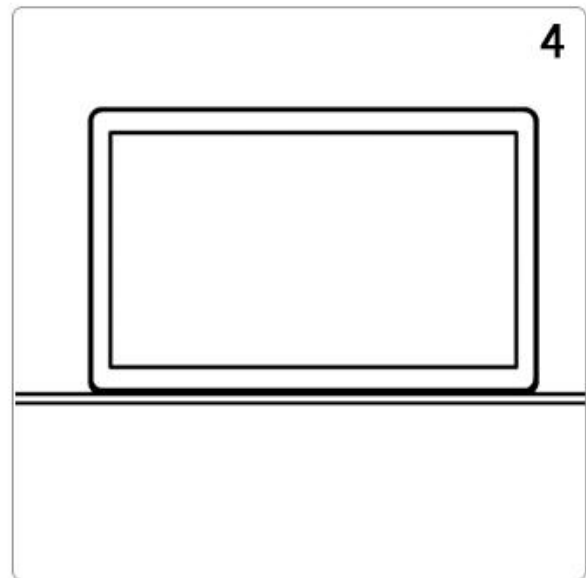
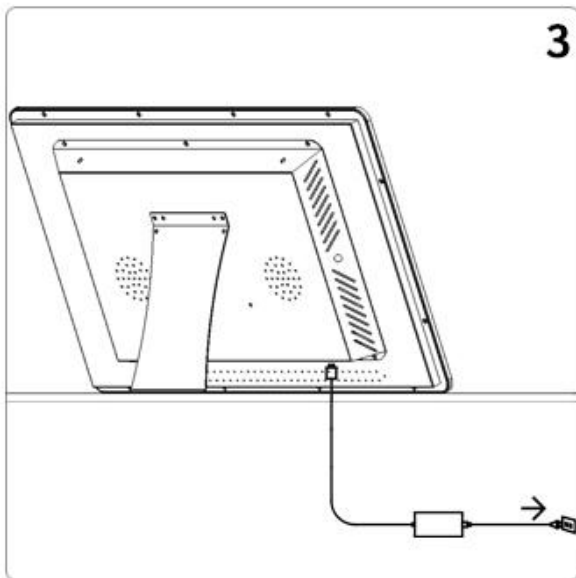
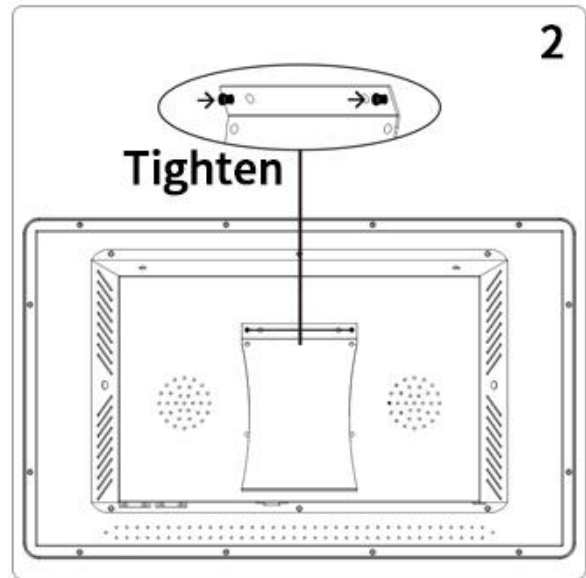
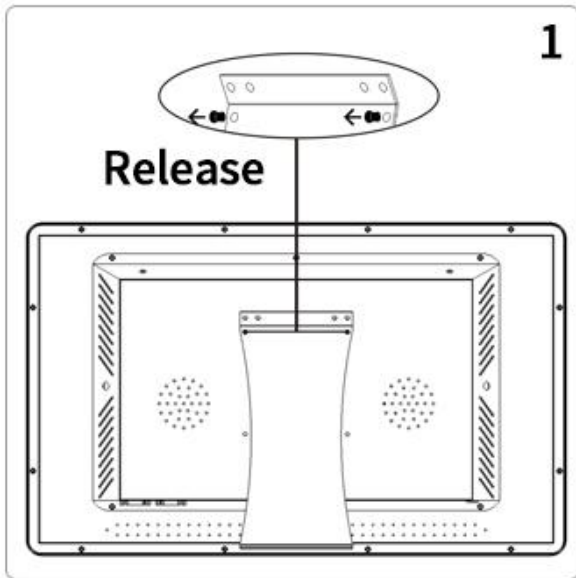

Wall bracket installation method

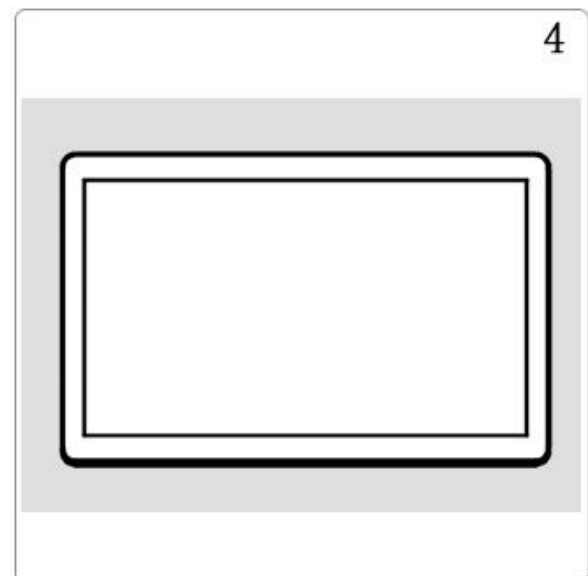
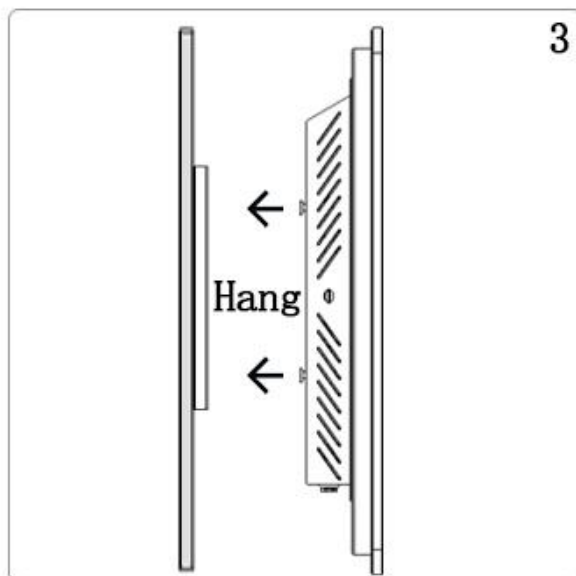
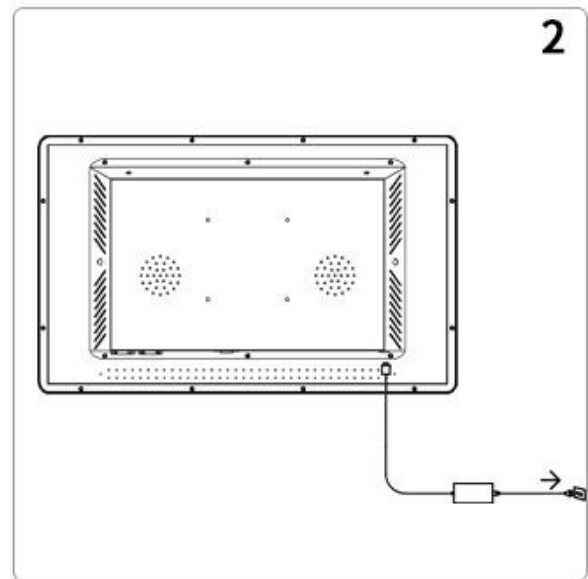
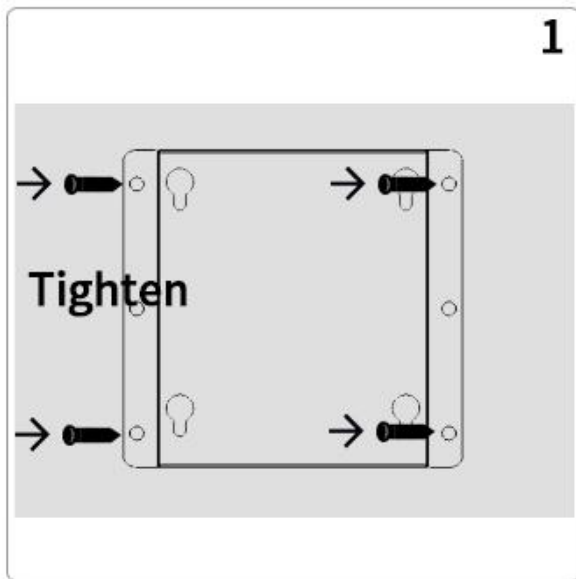

Interface display

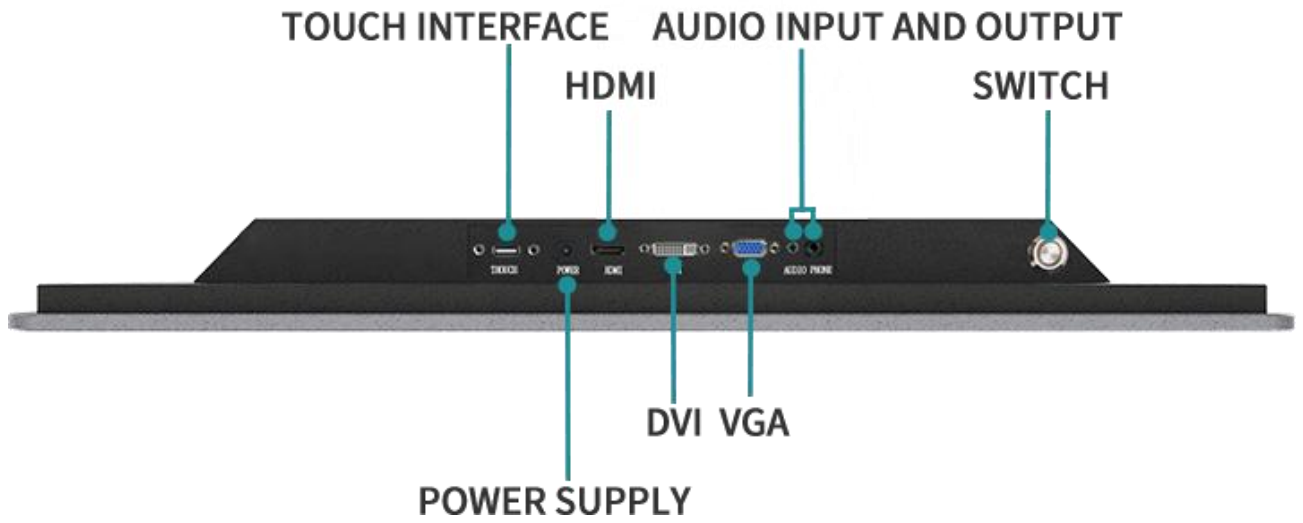

The above interfaces are standard interfaces for reference only. Different sizes and positions will vary. There are no green terminals as standard.

Installation & Instructions

Installation Notes

1. Open the package
2. Take out the power pack and the machine; install and fix the machine (different brackets have different installation methods, please refer to the "Bracket Installation Instructions" for details)
3. Connect the power adapter and connect the connected power adapter to the host



1. If the machine is not set to power on, press the "POWER" key switch after connecting the power supply.

Product Care and Maintenance

When you receive the product, please pay attention to check whether the outer packaging is damaged or deformed. If you find any damage or deformation, please contact the logistics personnel as soon as possible or open the packaging in the presence of the logistics personnel to check the internal damage of the product.

Individual brackets will be equipped with corresponding screws, please pay attention to the accessories.

When installing the bracket, please ensure that the product is installed firmly before use. Please pay attention to the placement of the column floor bracket, as it is easy to collide and fall to the ground.

Installation sequence: connect the signal cables between components first, and then connect the power cables. Only connect the power cable last when all components are properly connected.

During the installation process, the electrical safety regulations of the country and the region of use must be strictly observed. When the plug and socket are matched, they must be inserted in place. After checking that the connection is correct, tighten the plug screws to ensure a stable connection.

When choosing an adapter, please check whether the adapter meets the specifications for use. Please use an adapter that complies with local safety standards.

When connecting to AC power, it is required that the power plug is not easy to loosen after plugging in, and the plug must have a ground wire.

The installation should be carried out without electricity, and live installation is prohibited.

Power sequence: connect the adapter first, then connect the AC power.

You are responsible for configuring all passwords and other related product security settings reasonably, and keep the account username and password of the manager's authority properly.

If the device does not work properly, do not disassemble and repair it by yourself, otherwise it will affect the device warranty.

Ensure that the surface of the product is clean during use, so as to avoid dirt or dust particles covering the LCD screen and affecting normal use.

Avoid extreme high temperature (or low temperature), high humidity, vibration, radiation, chemical corrosion and other harsh or extreme environments during installation and use.

Machine maintenance requires professional personnel from our company or personnel trained by our company to operate to avoid unnecessary dangers